

sun eco  
ficha técnica  
datasheet

ref. 5550835

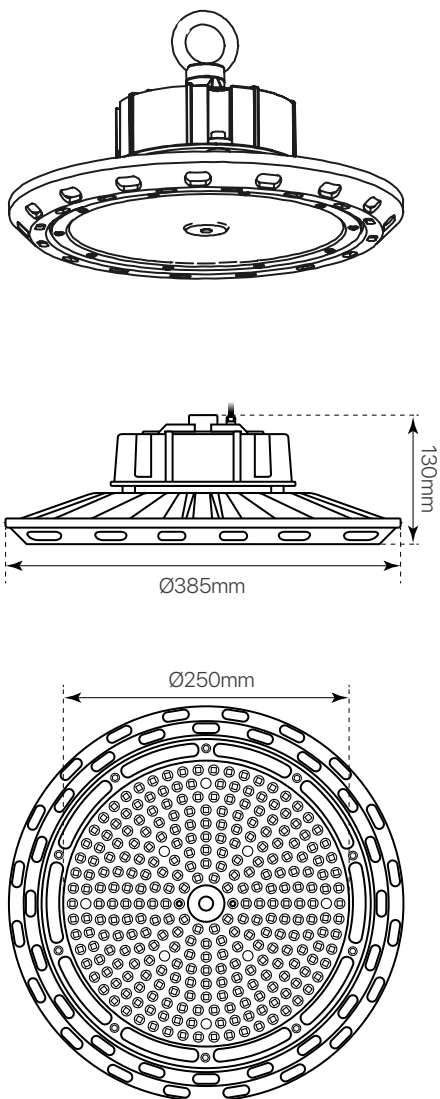

Nombre / Name	Sun eco, campana led 200W
Referencia / Reference	5550835
Materiales / Materials	Aluminio / Aluminum
Difusor / Diffuser	PC
Potencia / Power	200W
Temperatura de color / Color temperature	5500K
Flujo luminoso / Luminous flux	24000lm
Dimable / Dimmable	-
Ángulo de apertura / Beam angle	120°
Ángulo de inclinación / Inclination angle	-
IP	65
IK	08
F.P	>0,90
UGR	<25
IRC	>70
Chip	PHILIPS SMD 3030
Driver	inventronics
Vida media ( duración ) / Average life	> 25,000 h
Clase energética / Energy class	A++
Aislamiento eléctrico / Electrical isolation	Clase I / Class I
Colores / Colors	Negro / Black
Medida exterior / Product size	Ø385 mm x 130 mm
Protección contra Sobretensiones / surge protections	-
Tª ( ambiente/trabajo ) / Tª ( enviroment/work)	-20°C ~55°C
Input	AC 85 ~ 265V
Output	DC 42V
Frecuencia / Frequency	50/60Hz
Peso / Weight	5,6 kg
Certificados / Certificates	CE & RoHS
Garantía / Warranty	2 años